

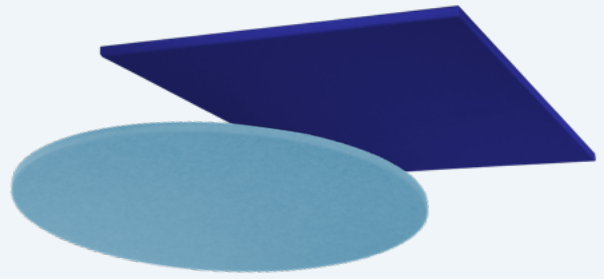

# Installation Manual

## ECOSCAPES

### 33"/4' Acoustic Clouds



Congratulations on purchasing your new EcoScapes Cloud kit from Primacoustic. EcoScapes Acoustic Clouds are high performance absorption panels that are designed to hang from the ceiling and capture ambient noise and reverberation. This is achieved by absorbing sound as it hits the face of the panel, while trapping powerful reflections behind as they echo off the ceiling. Please take a few minutes to read this installation manual. It will give you a list of included parts, as well as easy to follow assembly instructions and installation options.

Please refer to [www.primacoustic.com](http://www.primacoustic.com) for general room acoustics information and further details. Should you have any questions or comments, we invite you to send an email to [info@primacoustic.com](mailto:info@primacoustic.com)



#### Box Contents:

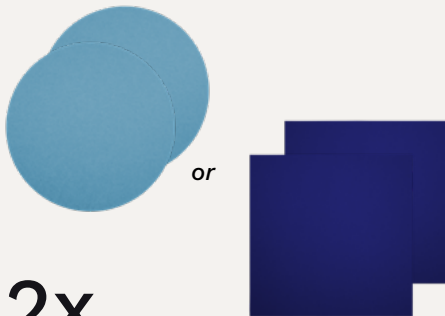

**2x**

High Density PET Acoustic Clouds  
4' x 4' x 1" (1,200mm x 1,200mm x 24mm)  
33" x 33" x 1" (838mm x 838mm x 24mm)

*Actual appearance may vary,  
depending on model purchased*

#### Hardware required *Sold separately:*



**8x**

76" Sheathed Aircraft Cable



**8x**

Ceiling Toggle w/Screws



**8x**

Cable Caps  
(two parts)



**8x**

Cable Anchor Set



**8x**

Optional Loop  
Attachment

Installation Guidelines

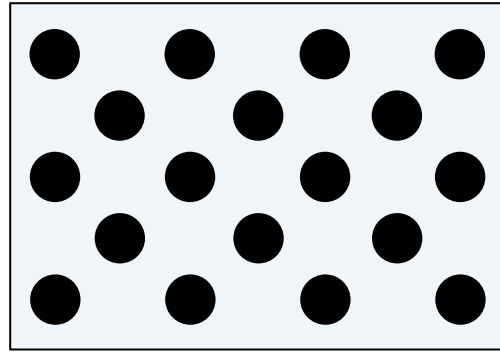
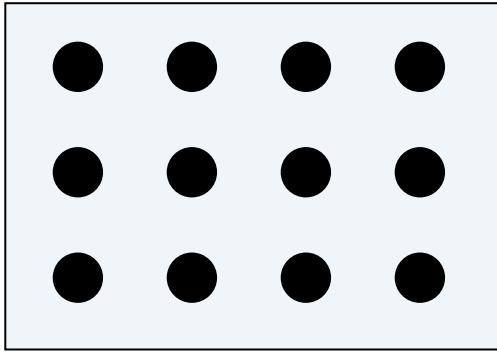

DENSITY

The number of clouds in a given area will determine the rate of sound absorption. This can vary depending on room size and noise levels.

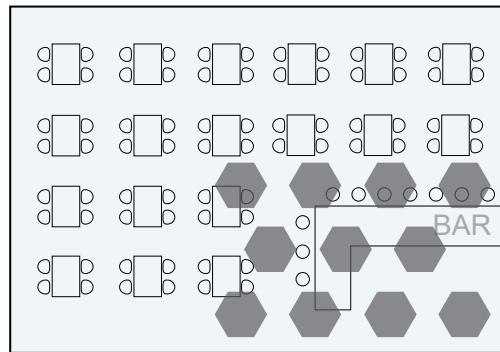
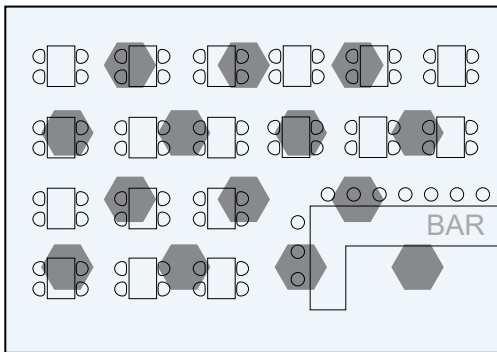

LOCATION

Spread evenly for general sound control, or concentrate over noisy areas to absorb sound before it can reflect.

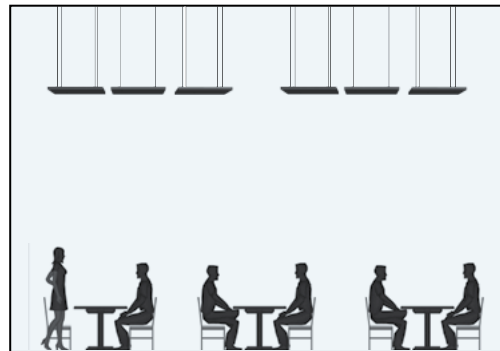
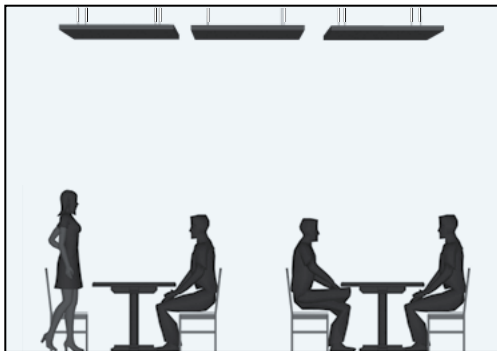

SUSPENSION HEIGHT

Leave a minimum 3" (76mm) of air space between the panel and ceiling, up to a maximum of 75" (150cm)

## Installation

### Tools & materials required:

- Measuring Tape
- Ladder/Scaffolding
- Drill 3/32" or 1/4" bit
- Screwdriver
- Hammer
- Wire Clippers

### 1. Ceiling Anchor Locations

Measure and mark your ceiling for suspension point locations. Pay close attention to where you want the panel to be located. This way the panel anchors will be directly below each ceiling mounting point. All cables should hang straight to create a dead hang.

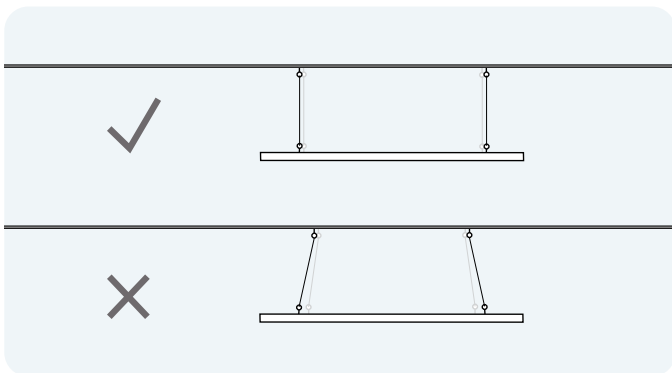

### 2. Panel Anchor Locations

Measure and mark the backside of the panel. Anchors should be a minimum of 4" (102mm) in from the panel's edge. Each anchor location should be spaced to match the location marked on the ceiling in the previous step.

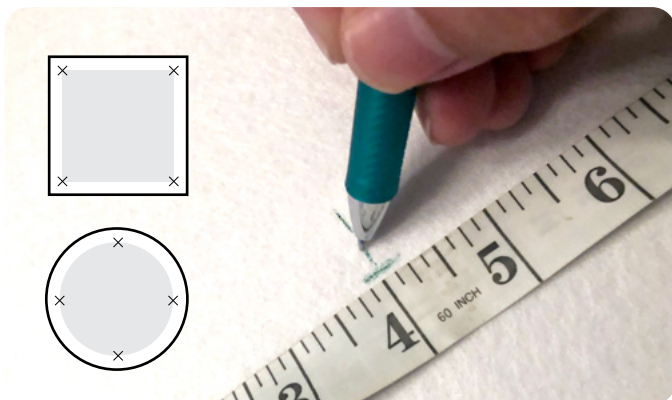

### 3. Attach PET Cable Anchor

Place anchor with the flat section on marks previously created. Screw the smaller screws through the plate's holes directly into the cloud panel until the head of the screw is flush and tight with the anchor plate. *NOTE: the screws will not fully tighten, however the connection will be very secure.*

Repeat for the other three anchors.

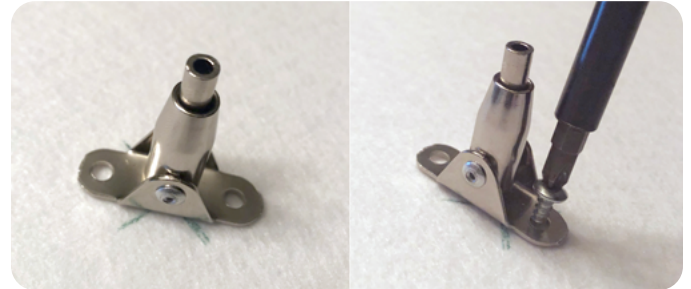

### 4. Installing Ceiling Anchors

Probe your ceiling to find out if there is a solid or hollow backing. Using a hammer tap a nail into each ceiling anchor location to determine the backing. Depending on the backing, choose one of the following two options:

#### Solid Backed Ceiling

If one or more of your ceiling anchor locations is on a solid backing, such as a joist, you do not need to use the included ceiling anchors. In such a case, use a 3/32" drill bit to make a pilot hole and screw the screw and Endcap in directly. Continue to step 5.

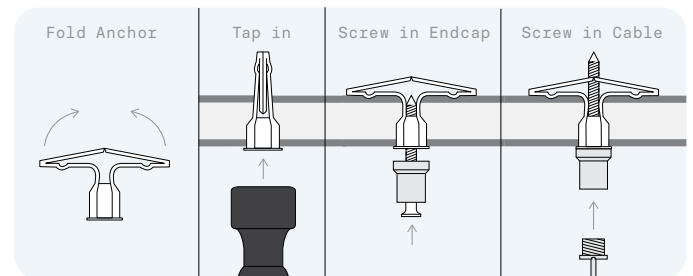
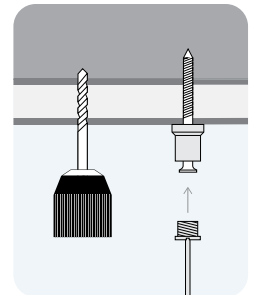

#### Hollow Backed Ceiling

If the your ceiling backing is hollow, use a 1/4" drill bit to make a hole for the butterfly anchor. Continue to step 5.

**Suspending the clouds from a beam**

The hardware kit contains an optional attachment used to create a secure hold when looping the suspension cables around a beam. Please check the maximum weight the beam can hold before suspending panels.

Thread the unterminated end of the cable through the first hole in the attachment and pull the full length of cable through. Loop the cable loosely over the beam, then thread the cable back through the second hole in the attachment. Finally pull the cable tight around the beam, and tighten the screws at either end of the attachment. Repeat for the other three cables. Attach the panels, then suspend and level as shown in steps 6 & 7.

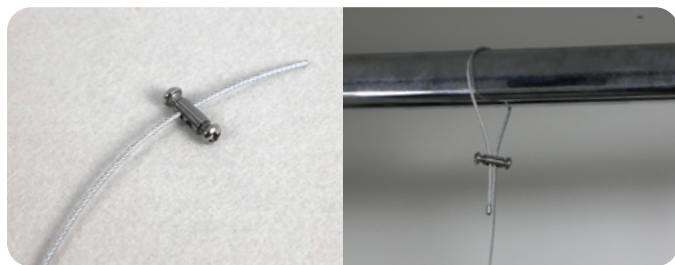

**5. Install The Cable Endcap**

Pass the unterminated end of the cable through the cable cap. Screw the ceiling cap into the ceiling anchor using the longer screws. Screw the cable cap into the ceiling cap.



**6. Attach The Cloud Panel**

Angle the cable anchor at 45 degrees. Insert the loose end of the cable into the top of the anchor, pushing firmly to engage the cable into the anchoring mechanism. You should be able to see the cable protruding through the bottom.

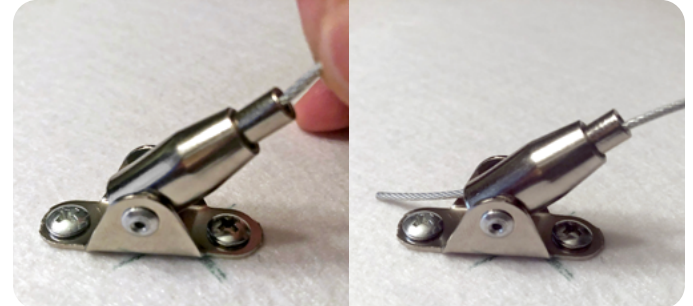

**7. Suspend and Level**

With the panel suspended, pull the cable through to adjust the panel's distance from the ceiling.

Fine-tune the lengths of the cable by pressing on the center sleeve of the anchor to release the cable. For the best acoustic performance, maintain a minimum of 3" (76mm) between cloud and ceiling.

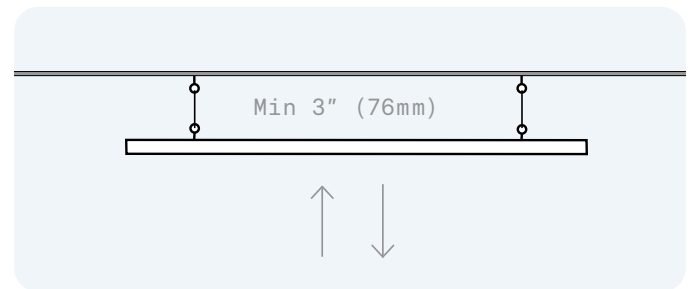

**Limited Warranty**

Please inspect products immediately after receiving your purchase. Primacoustic acoustic products are guaranteed to be free of manufacturing defects for a period of 3 years after purchase. In the unlikely event that a defect is uncovered, please call 604-942-1001 to obtain a RA number (Return Authorization number) from Primacoustic before the 3 year warranty period expires. Once you have obtained a RA number you must return the product, freight prepaid, within fifteen (15) days after the date the RA number is issued. Please return the product in the original packaging (or another, affording an equal degree of protection) with all of the following: (1) RA number clearly marked on the returned package; (2) a receipt or bill of sale showing proof of purchase from an authorized seller; plus (3) a letter describing the defect. Please include your name, address, telephone number and the applicable RA number. You are solely responsible for all shipping and insurance costs for returning the product to Primacoustic, and you will not be reimbursed or compensated for any loss or damage incurred during return shipping. Primacoustic will at its sole discretion repair or replace the product. Should the product no longer be available, Primacoustic reserves the right to exchange this with a product of similar performance and value. Due to different dye lots, Primacoustic cannot guarantee exact color match. This Warranty shall solely extend to the original owner and is limited to manufacturing defects and excludes damage due to improper installation, freight handling, wear and tear, abuse, misuse, misapplication, color fading or deterioration due to prolonged exposure to ultra violet light, smoke, humidity or other environmental factors. It is understood that the use and suitability of the product is entirely the responsibility of the buyer or specifying engineer and as such, these parties agree to hold Primacoustic, or its associated company, and/or officers, harmless from any responsibility whatsoever other than what is clearly outlined in this warranty.